



BALLAST WATER TREATMENT SYSTEM

GI **En-Patrol™**

BWTS RETROFIT Guide Book

ENGLISH

PANASIA

B W T S RETROFIT Guide Book

CONTENTS

Introduction	06
Engineering	10
1) Pre-Engineering	10
2) Detail Engineering	13
Service	17
1) Project management	17
2) Supervision	18
Case Study	20
1) Dry Docking	
- Engine Room	22
- Engine Room & Pump Room	30
- On Deck	32
- Machinery Room	34
2) On Voyage	
- Engine Room	38
3) Berthing	
- Engine Room	44
GloEn-Patrol™	48
1) GloEn-Patrol™	50
2) GloEn-Patrol™ Component	
- Filter unit	54
- UV unit	56
- Panels	58
• Worldwide Service Network	59





**We will be the best partner for
BWTS Retrofit on existing ships.**

PANASIA E&S is a Retrofit specialized engineering company which provides engineering and services for BWTS retrofit construction.

Based on the technologically proven experiences, it has become a global company with high recognition in domestic and overseas, which offers in-depth level of service on high-end engineering and customer friendly services.

PANASIA E&S, which provides the best solution for the customers' ships, will be the best partner in a field of BWTS retrofit construction on existing ships through various technical consulting works.



The wide range of BWTS Retrofit contract scope is available for the ease of customer.

<p>EQUIPMENT SUPPLIER</p> <ul style="list-style-type: none"> - BWTS Equipment - Commissioning - Demonstration 	<p>Engineering Company</p> <ul style="list-style-type: none"> - Onboard Survey - Basic Design - Owner/ Class plan approval - Interface with existing automation system 	<p>Design Company</p> <ul style="list-style-type: none"> - Installation drawing - Manufacturing drawing
<p>Outfitting Material Supplier</p> <ul style="list-style-type: none"> - Steel Structures - Pipe Spools - Cables - Installation Materials 	<p>Installation Labor</p> <ul style="list-style-type: none"> - Pipe spools installation - Laying & connection cables 	<p>Supervisor</p> <ul style="list-style-type: none"> - Schedule control - Quality control - Instruction to workers

The scopes of BWTS retrofit contracts are divided into four types.

CASE 1	BWTS Equipment only + Construction works
CASE 2	BWTS Equipment + Engineering + Construction works
CASE 3	BWTS Equipment + Engineering + Materials (pipes, steel outfitting, electricity) + Construction works
CASE 4	BWTS Equipment + Engineering + Materials (pipes, steel outfitting, electricity) + Installation works + Construction works



BWTS retrofit of PANASIA E&S has the technical capability to complete the entire process from equipment supply to engineering and construction.

In addition, selecting only the equipment of BWTS (GloEn-Patrol™), or only a part or parts of the whole processes among engineering, installation construction materials, and installation works together.

As the number of companies participating in the entire process increases, the work process may not go smoothly; and it becomes not easy to identify the exact responsible party in case of a problem.

Instead, retrofit specialist team of PANASIA E&S has never made responsibility problem like postponement of the deadline or additional charges while working on a number of projects.

Retrofit Process

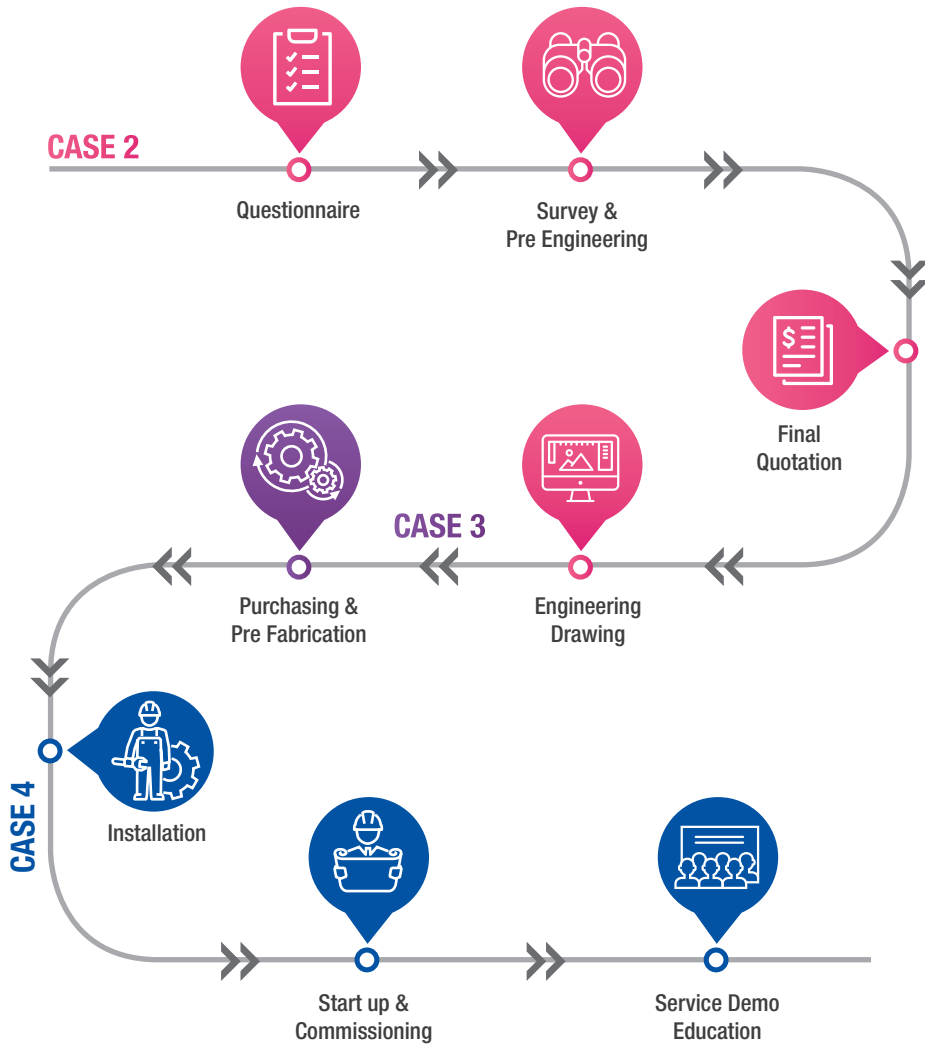

Estimated procedure time

- The entire process time is divided into two types by installation conditions

Drydock or Quay



On voyage



BWTS retrofit takes an average of 13 weeks and a separate period for product delivery is needed to complete the installation after the contract.

Customers should be careful in choosing contract signing date considering the expected time for BWTS installations on the ship according to each condition.

However, the period of installation of 'construction on voyage' may vary depending on the number of people available on board.

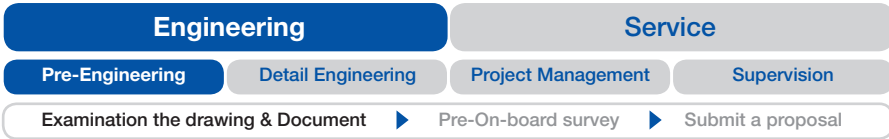

Examination the drawing & Document

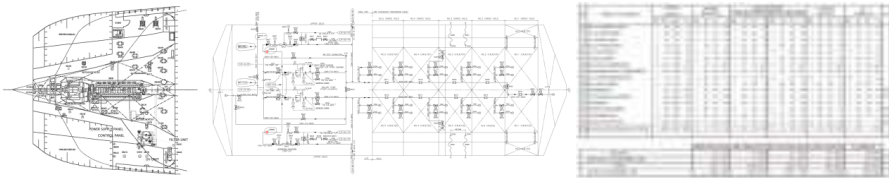

General Arrangement

P & ID

Electric Load Analysis Drawing

<Table 1>

Drawing List	1. General Arrangement	
	2. Machinery Arrangement	To check available space for equipment
	3. Electric Equipment Arrangement	
	4. P & ID	To check how to modify the piping system
	5. Electric Load Analysis Drawing	To check available power
	6. Wiring diagram of Power System	To check the general specification of power system
	7. Wiring Diagram of Control System	To check how to interface with existing automation system like GPS or AMS
	8. Maker DWG of Group Starter Panel	To monitor of pump running status
	9. Maker DWG of VRC System	To monitor status of some valve related ballasting system

In order to commence the retrofit installation of the existing ship, client companies should provide information as shown in <Table 1>.

Before visiting aboard ship, detailed inspection on the ship's specifications and drawings minimizes the errors in budget estimation and helps higher quality of on-board inspection.

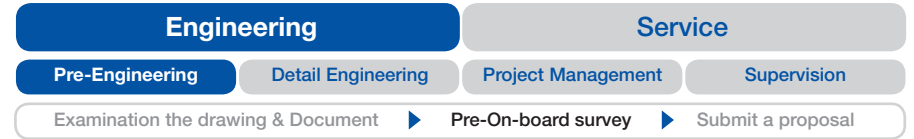

Pre-On-board survey



BWTS Passage check

Space check

Size check



Pump piping line check

Laser 3D scanning

On-board survey carrying out at the ship's berthing schedule aims at collecting fruitful data to create the actual drawings.

This step is to check and secure spaces where GloEn-Patrol™ BWTS should be mounted; the installation location is filmed by laser 3D scanner, and pre measured data are reviewed to figure out if existing facilities are bothered or damaged from newly to be installed BWTS including pump piping lines to find efficient space use.

Engineering

Service

Pre-Engineering

Detail Engineering

Project Management

Supervision

Examination the drawing & Document

Pre-On-board survey

Submit a proposal



Submit a proposal

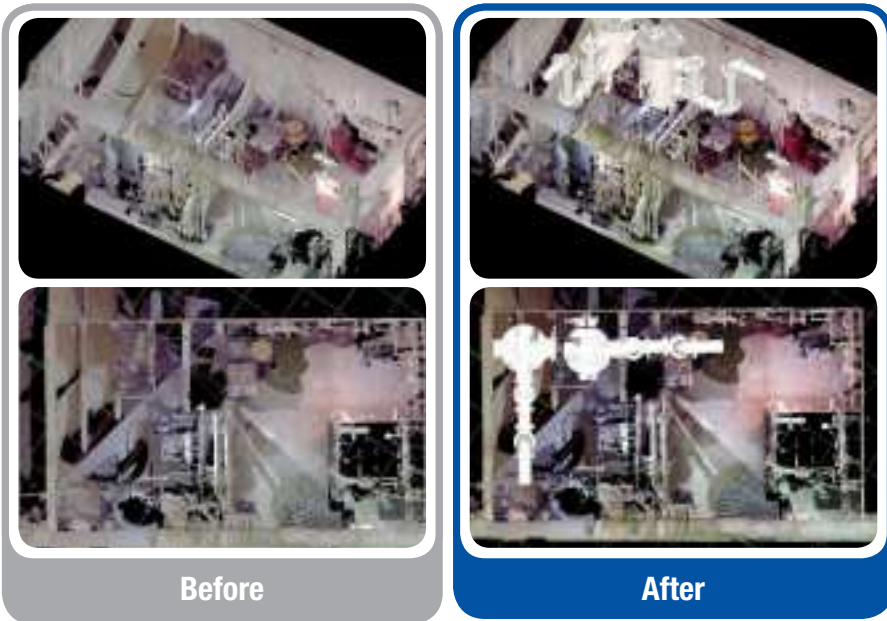

Using the scanned data obtained through the Laser 3D scanner, 3D simulation of the mounted GloEn-Patrol™ BWTS is provided to ship owners.

This allows ship owners to easily compare and understand before and after installations concept.

Data collected from on-board inspection become the critical sources for prime cost estimation, and offer documentation which will be submitted to customers for contractual consideration.

Engineering

Service

Pre-Engineering

Detail Engineering

Project Management

Supervision

On-board survey

Installation Drawing

Manufacturing Drawing



On-board survey

This step is to make a close investigation for detailed design after the contract.

In this step, we perform a precise 3D scanning on the install location of BWTS and the whole installation route of new pipes and steel outfitting, and investigate signal coupling methods of the power source of BWTS and the existing system of ships such as AMS and GPS.

The 3D Scan data taken from the ship is converted into modeling after reverse engineering process, and the layout design is performed by synthesizing the modeling of BWTS UNIT.

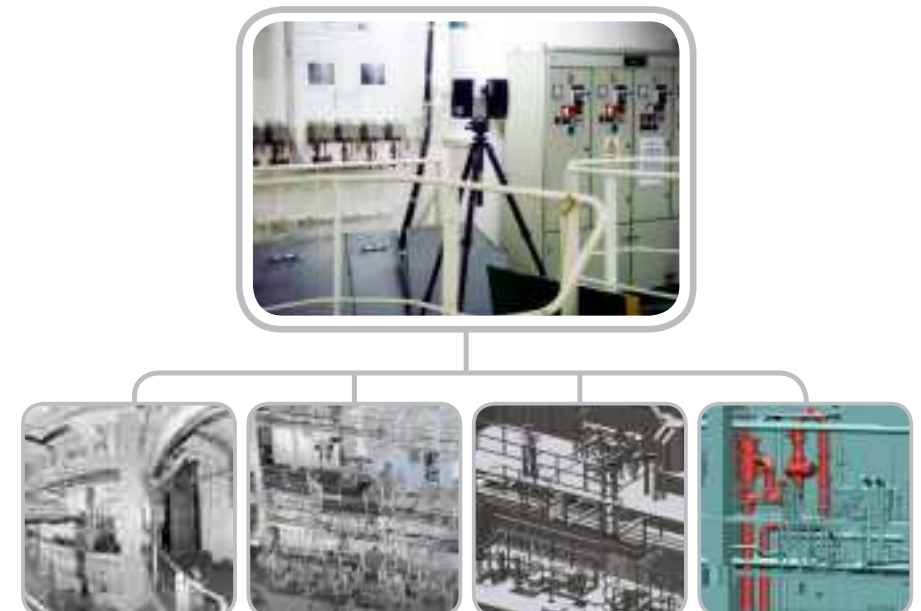



Installation Drawing

This step is to work on detailed installation drawing based on precise 3D scanning data.

In this step, we provide multiple angled drawings such as ISO View, Section view, Elev. View, etc. and detailed explanation to lead sufficient discussions with ship owners for better understanding.

In general, workers engaged in the ship repair industry often work based on their experience rather than drawing details. Considering complexity of construction process of BWTS, we provide easy-to-understand installation drawings in which part numbers and assembly sequences are precisely described to all items for smooth and accurate BWTS retrofit works. The drawing will be the standard when ordering material to its supplier.

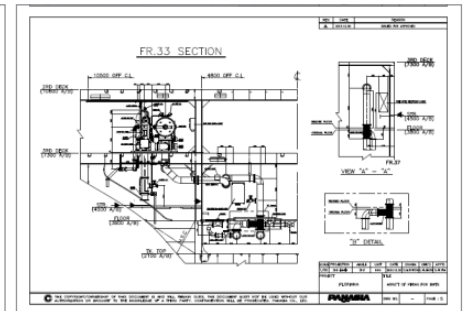
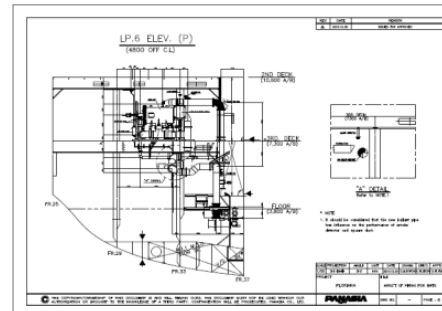
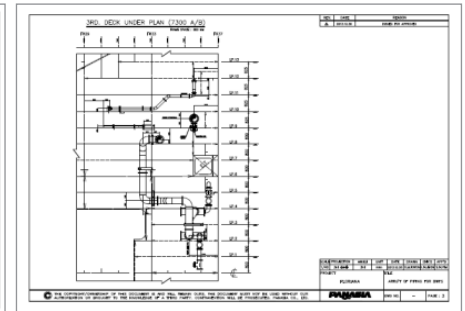
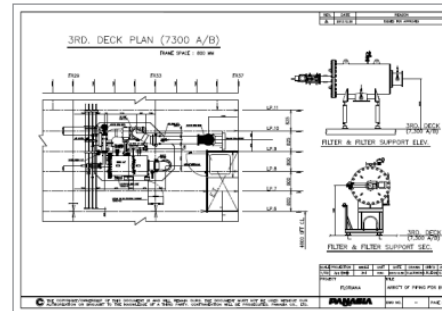
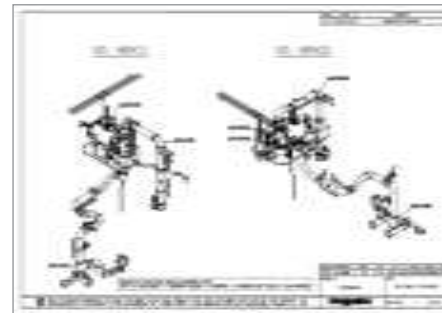
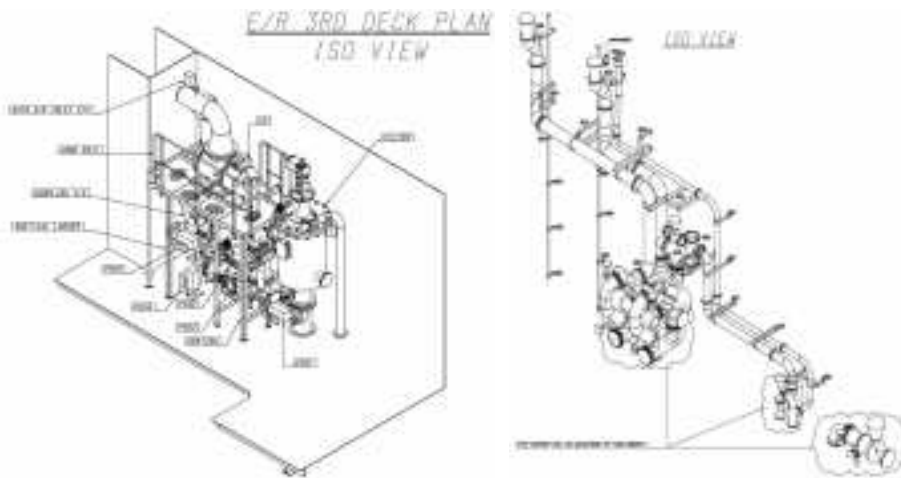

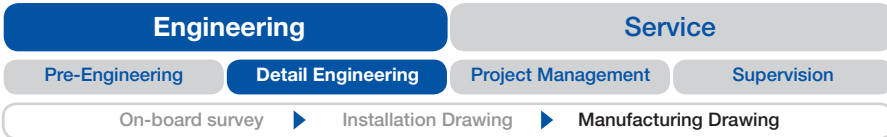

Manufacturing Drawing

This step is to prepare the manufacturing drawings for each drawing after completing the installation drawing design.

We work on actual drawings based on detailed information such as piece numbers, dimensions, materials, standards, surface treatment, and paint specifications.

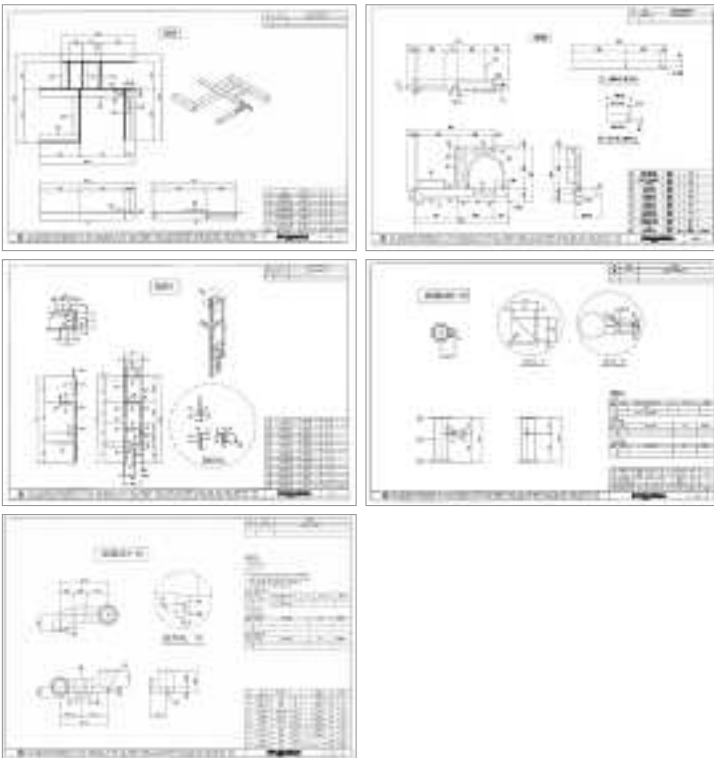

Schedule Management

Ship Owner		SAMPLE		INSTALLATION SCHEDULE FOR BWTS RETROFIT PROJECT						Approved								
Vessel Name		PANASIA								Checked								
Shipyard		Shipyard								Drawing								
Class		DNV/GL								Date / Rev.								
				2015. 4 (April)					2015. 5 (May)									
22	23	24	25	26	27	28	29	30	1	2	3	4	5	6	7	8	9	10

- NOTE ◀
- Vessel has to be at sea to use ballast pump when we carry out commissioning.
 - Expected vessel schedule (ETA: 23th April / ETD: 7th, May)
 - According to above expected vessel schedule, shipyard has to finish BWTS installation work including test by 4th, May.
 - We PANASIA recommend shipyard divide four(4) work area and assign workers (fitter, welder) to each area.
 - Four(4) work areas means 1) Engine Room, 2) Upper Deck, 3) Inside of NO.3 WBT(P) 4) Inside of NO.3 WBT(S).
 - If shipowner want to extend PANASIA supervision, make extra order to our office (PIC: Allen, Jeong / E-mail: japan@worldpanasia.com)

In this step, we set detailed schedules in reverse order from D-day considering the lead time of each group depending on installation (drydocking) schedule.

At this time, PANASIA E&S acts as a project manager(PM) for all schedules, checking the progress and reporting it to the client companies. PANASIA E&S arranges the entire detailed schedule and informs client companies of it.

Ship owners are not required to contact each party and available to coordinate all schedules with PANASIA E&S, the PM, so that retrofit construction will be much more easier.

Engineering

Service

Pre-Engineering

Detail Engineering

Project Management

Supervision

A supervisor can be assigned if included in the contract.

The supervisor manages and supervises whether the construction is under the instruction of the drawings in order to check the progress of the construction so that entire schedule is always in check of PANASIA E&S.

In order to prevent the unexpected situation such as damaged materials or omissions from affecting the whole schedule, PANASIA E&S identifies whether materials delivered have been damaged or not, and reports to suppliers to provide replacements in advance. Moreover, PANASIA E&S cooperates at site with engineers for other equipment manufacturers (VRCS, AMS, etc.) that are interfaced with BWTS.

You will successfully the retrofit installation through the supervision for BWTS



Two documents: a technical specification sheet on the left and a detailed parts list table on the right.

Engineering

Service

Pre-Engineering

Detail Engineering

Project Management

Supervision



Step 1

Management of installation work schedule, consultation

- Consultation on installation schedule and process with repair shipyard



Step 3

Implementation of construction supervision

- Equipment and various pipes, Parts for installation valves
- Electricity installation and Interface Part for equipment



Step 2

Check on equipment and materials

- Check if equipment and materials have been missing or damaged



Step 4

Work cooperation with A.M.S Maker

- After consultation with A.M.S Maker, program modification and confirmation of whether the Alarm works properly are implemented.





Ultimate confidence in the best BWTS Retrofit construction.

PANASIA E&S presents innovative tech-consulting where highly efficient space utilization as per vessel structure.

Large types of vessels with a variety kind of installation conditions have perfectly completed retrofit construction with PANASIA E&S. Among all records, there was no any construction deferral or additional expenses.

Widely experienced technic of PANASIA E&S provides the best and optimal solution to become the best partner in BWTS retrofit construction.

- Dry Docking
- On Voyage
- Berthing
- Engine Room
- Pump Room (Tanker)
- On Deck
- Machinery Room

ASPHALT SEMINOLE



Ship owner	SARGEANT MARINE (USA)
Ship type	Asphalt carrier
Shipyard	Sembangwang Shipyard (Singapore)
Treatment capacity	250 m ³ /h x 1set
Period	Dec 2014

- On board survey
3D Laser Scanning
- Installation
- Commissioning
- Complete

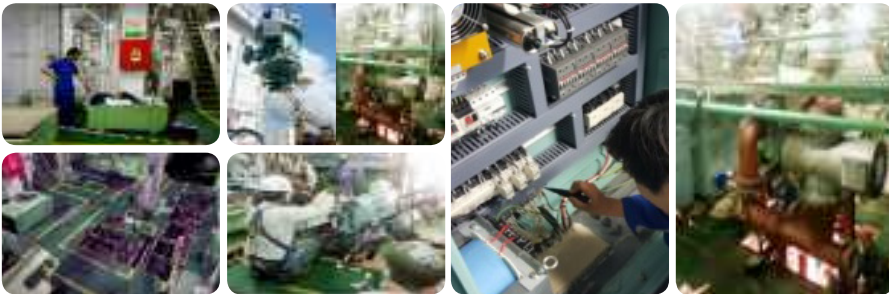

Material consumption

ITEM	SPEC'	Q'TY (pcs)	WEIGHT (kg)
PIPE (MAIN LINE)	200A (8")	47	2,847
PIPE (DRAIN)	50A (2")	5	44
SEAT & SUPPORT	-	91	1,231
CABLE	-	540m	263

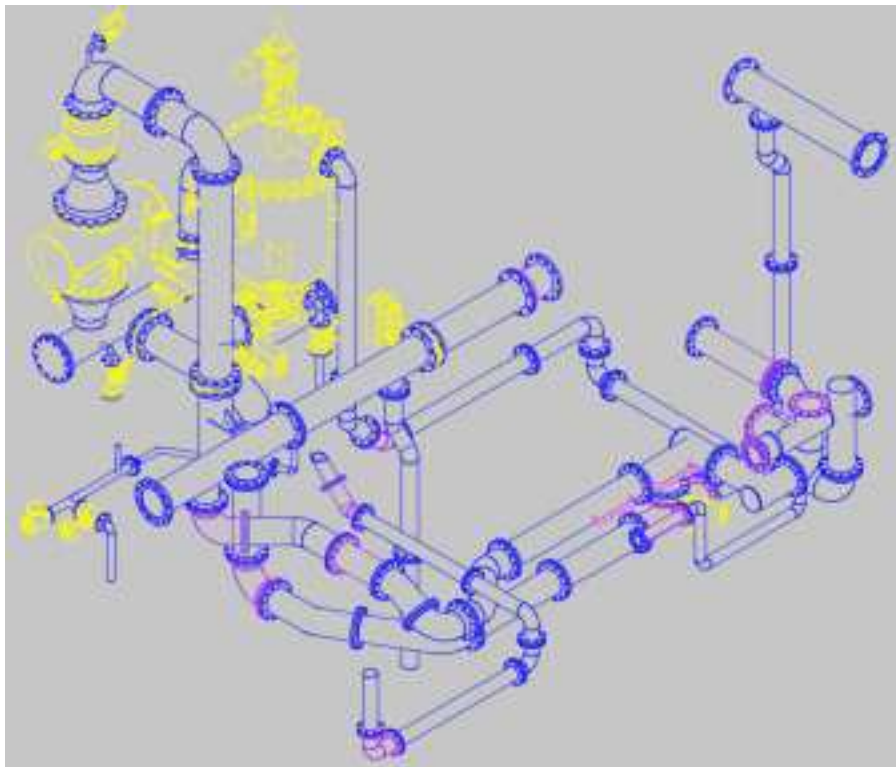

Dry Docking

On Voyage

Berthing

Engine Room

Pump Room (Tanker)

On Deck

Machinery Room

MV LAVAUX



Ship owner	SUISSE ATLANTIQUE S.A (Switzerland)
Ship type	38K Bulk carrier
Shipyard	Quindao Beihai Shipyard (China)
Treatment capacity	1,500 m³/h x 1set
Period	May 2015

Material consumption

ITEM	SPEC'	Q'TY (pcs)	WEIGHT (kg)
PIPE (MAIN LINE)	450A (18")	74	7,715
PIPE (DRAIN)	50A (2")	38	651
SEAT & SUPPORT	-	48	1,792
CABLE	-	2,676m	1,858

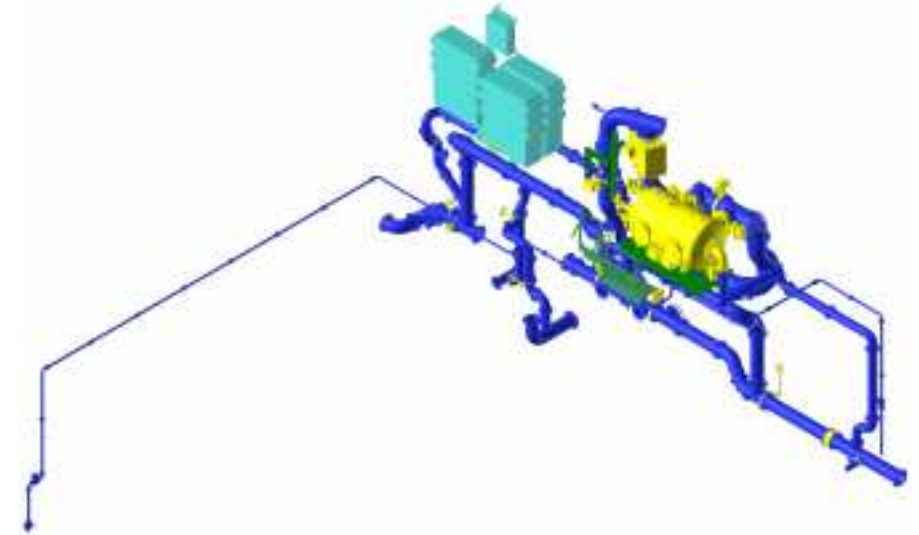

Before



After



- Dry Docking
- On Voyage
- Berthing
- Engine Room
- Pump Room (Tanker)
- On Deck
- Machinery Room

GAS VISION



Ship owner	KSS SHIPPING (Korea)
Ship type	50K LPG TANKER
Shipyard	MMHE (MALAYSIA)
Treatment capacity	1,500 m³/h x 1set
Period	FEB 2012

- On board survey
3D Laser Scanning
- Installation
- Commissioning
- Complete



Material consumption

ITEM	SPEC'	Q'TY (pcs)	WEIGHT (kg)
PIPE (MAIN LINE)	400A (16")	56	6,331
PIPE (DRAIN)	40A (1 1/2")	63	339
SEAT & SUPPORT	-	68	2,814
CABLE	-	1,634m	1,121

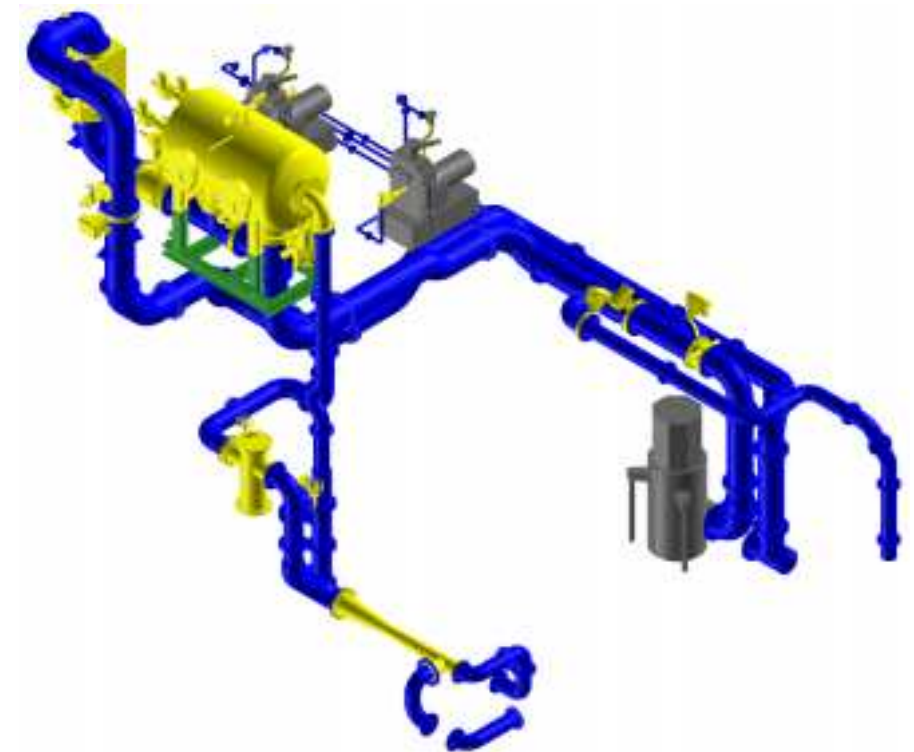

Dry Docking

On Voyage

Berthing

Engine Room

Pump Room (Tanker)

On Deck

Machinery Room

GAS VISION Retrofit Project



Before

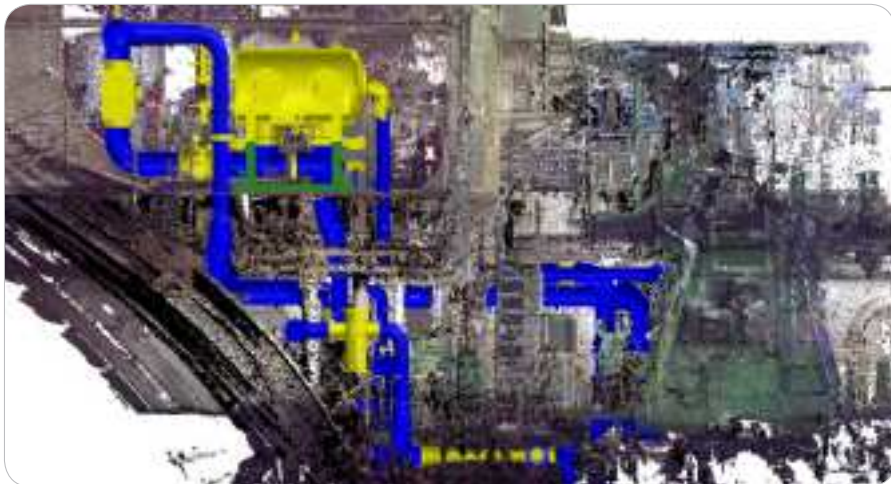

After



Before



After



Before

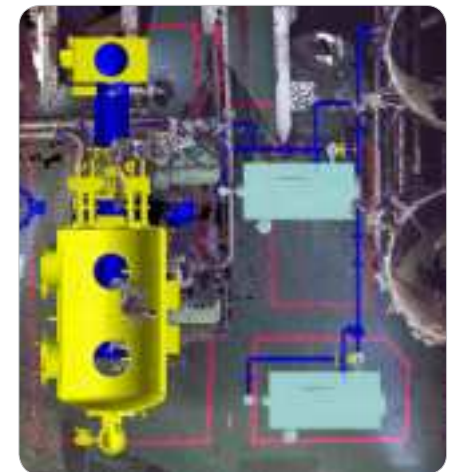

After

- Dry Docking
- On Voyage
- Berthing
- Engine Room
- Pump Room (Tanker)
- On Deck
- Machinery Room

Engine Room & Pump Room Retrofit Project

Ship owner	Japanese owner
Ship type	50K Product / Chemical Tanker
Shipyard	Singapore
Treatment capacity	2,000 m³/h (EX) x 1set + 350 m³/h x 1set
Period	Jan 2016



Material consumption

ITEM	Pump Room			Pump Room		
	SPEC'	Q'TY (pcs)	WEIGHT (kg)	SPEC'	Q'TY (pcs)	WEIGHT (kg)
PIPE (MAIN LINE)	450A (18")	60	8,098	250A (10")	43	2,380
PIPE (DRAIN)	40A (1 ½")	21	92	40A (1 ½")	11	191
SEAT & SUPPORT	-	69	1,666	-	29	455
CABLE	-	3,468m	1728	-	769m	328



Before



After



Before

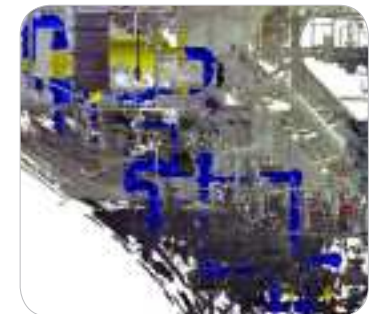

After

Dry Docking
On Voyage
Berthing

Engine Room
Pump Room (Tanker)
On Deck
Machinery Room

On Deck type Retrofit Project

Ship owner	Japanese owner
Ship type	50K Product / Chemical Tanker
Shipyard	China
Treatment capacity	1,500 m ³ /h (EX) x 1set + 250 m ³ /h x 1set
Period	April 2016



Material consumption

ITEM	Upper Deck			Engine Room		
	SPEC'	Q'TY (pcs)	WEIGHT (kg)	SPEC'	Q'TY (pcs)	WEIGHT (kg)
PIPE (MAIN LINE)	300A (12")	255	26,301	200A (8")	52	3,340
PIPE (DRAIN)	-	-	-	25A (1")	14	40
SEAT & SUPPORT	-	141	3,149.6	-	58	652
CABLE	-	2,272m	1,221	-	917m	351



Before



After



Before

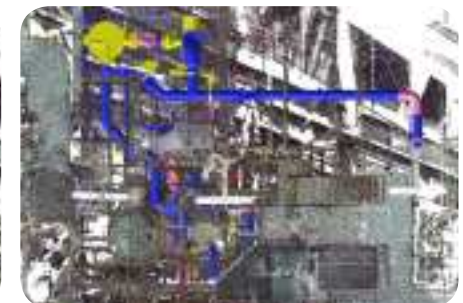

After

Dry Docking

On Voyage

Berthing

Engine Room

Pump Room (Tanker)

On Deck

Machinery Room

ARAON



Ship owner	Korea Polar Research Institute (Korea)
Ship type	Ice breaking research vessel
Shipyard	Yeosu Haeyang (Korea)
Treatment capacity	150 m ³ /h x 2sets
Period	June 2015

Material consumption

ITEM	SPEC'	Q'TY (pcs)	WEIGHT (kg)
PIPE (MAIN LINE)	150A (4")	53	2,599
PIPE (DRAIN)	40A (1 1/2")	13	316
SEAT & SUPPORT	-	19	285
CABLE	-	1,570m	561

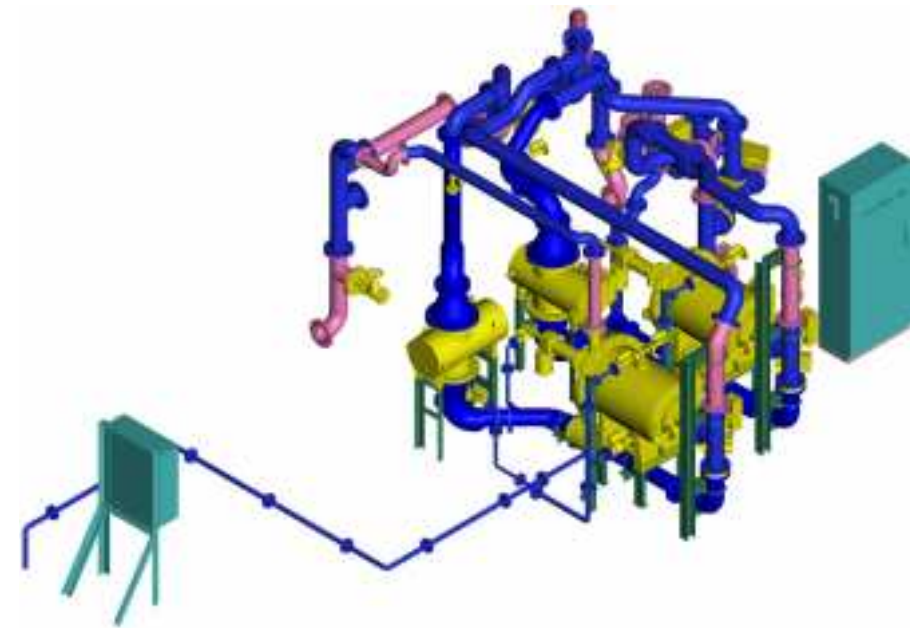

On board survey
3D Laser Scanning

Installation

Commissioning

Complete

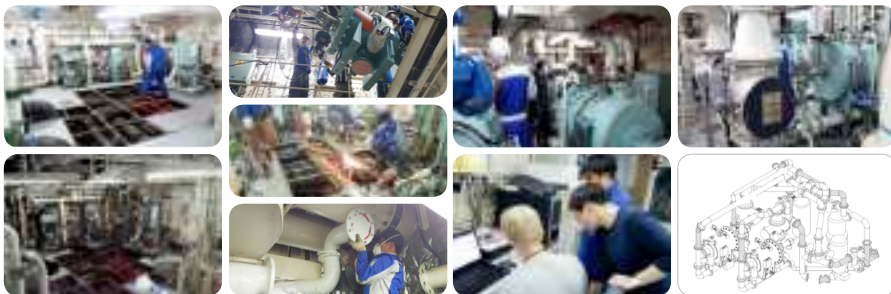

Dry Docking

On Voyage

Berthing

Engine Room

Pump Room (Tanker)

On Deck

Machinery Room

ARAON Retrofit Project

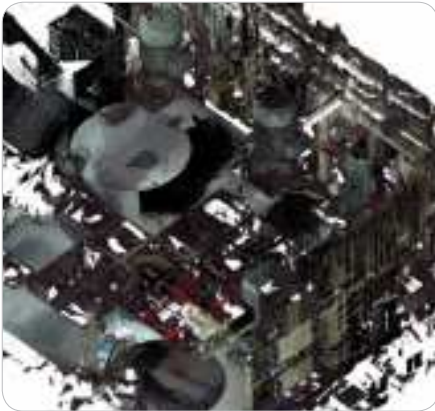

Before

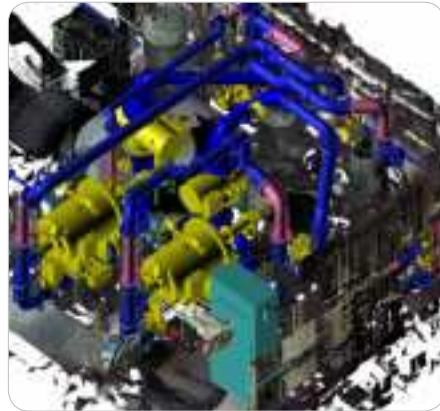

After



Before

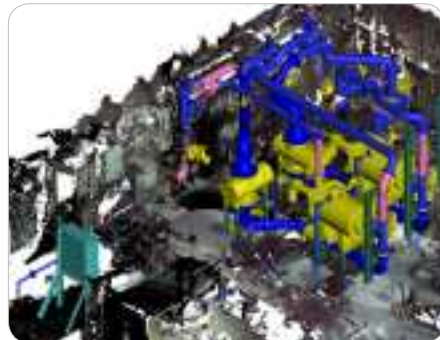

After



Before



After

- Dry Docking
- On Voyage**
- Berthing
- Engine Room
- Pump Room (Tanker)
- On Deck
- Machinery Room

MV FLORIANA



Ship owner	TRANS SHIP (Ukraina)
Ship type	34K Bulk carrier
Treatment capacity	700 m³/h x 1set
Period	June - July 2014

- On board survey
3D Laser Scanning
- Installation
- Commissioning
- Complete



Material consumption

ITEM	SPEC'	Q'TY (pcs)	WEIGHT (kg)
PIPE (MAIN LINE)	300A (12")	36	3,687
PIPE (DRAIN)	40A (1 1/2")	13	70
SEAT & SUPPORT	-	74	827
CABLE	-	1,755m	679

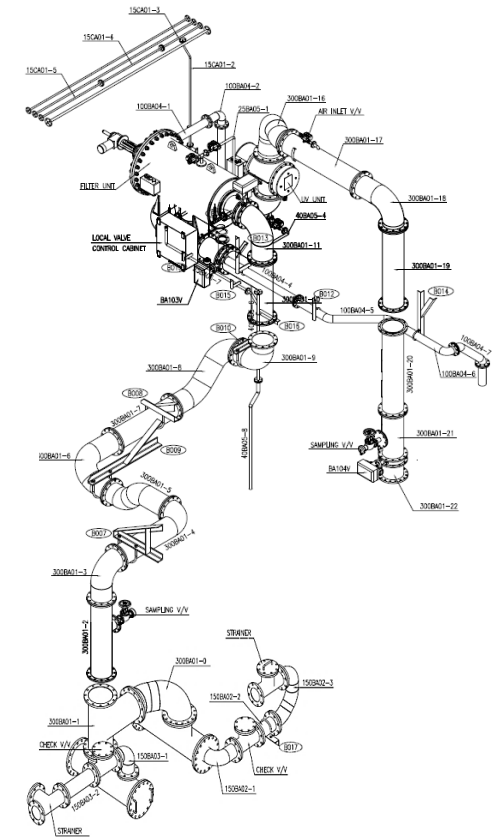

- Dry Docking
- On Voyage
- Berthing
- Engine Room
- Pump Room (Tanker)
- On Deck
- Machinery Room

WOORYANG BANDERS



Ship owner	WOORYANG SHIPPING(Korea)
Ship type	73K Bulk carrier
Treatment capacity	1000 m ³ /h x 2sets
Period	July – September, 2016

- On board survey
3D Laser Scanning
- Installation
- Commissioning
- Complete



Material consumption

ITEM	SPEC'	Q'TY (pcs)	WEIGHT (kg)
PIPE (MAIN LINE)	350A	89	7,921
PIPE (DRAIN)	40A	31	216
SEAT & SUPPORT	-	214	4,719
CABLE	-	3,194m	1,235

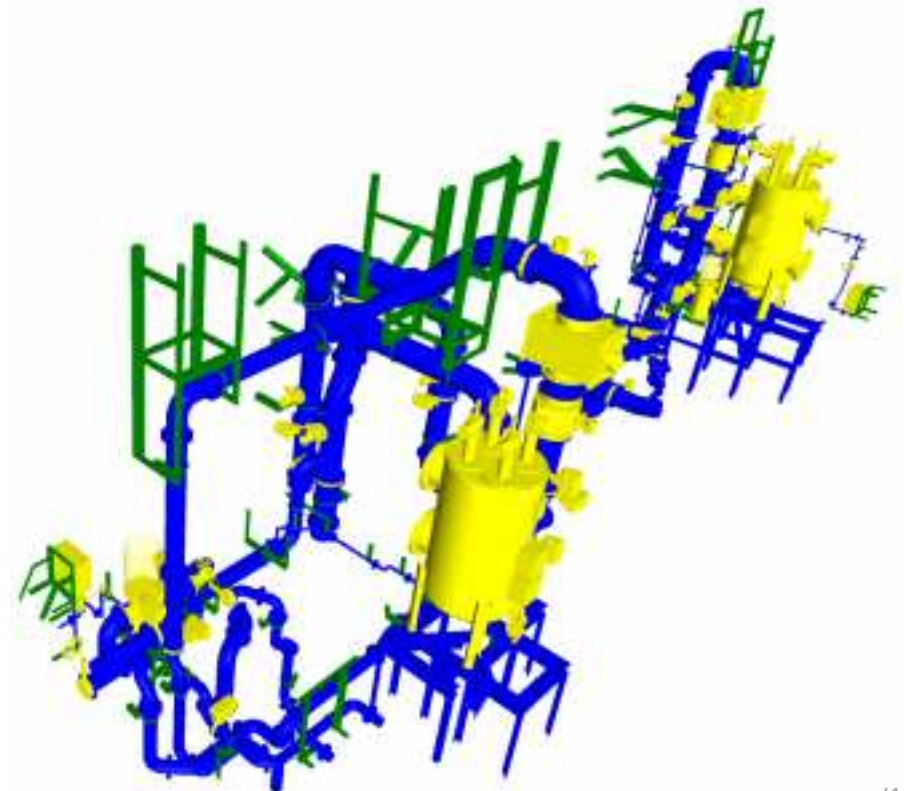

Dry Docking

On Voyage

Berthing

Engine Room

Pump Room (Tanker)

On Deck

Machinery Room

WOUYANG BANDERS Retrofit Project



Before



After



Before

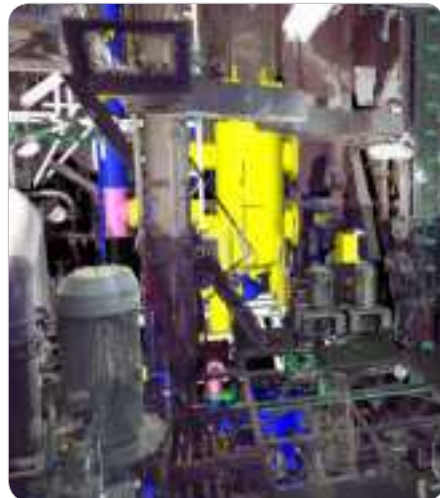

After



Before

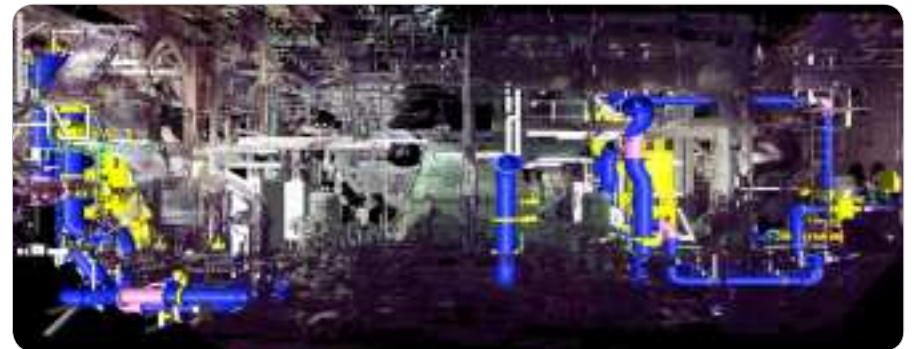

After

- Dry Docking
- On Voyage
- Berthing
- Engine Room
- Pump Room (Tanker)
- On Deck
- Machinery Room

ORANGE WAVE



Ship owner	ATLANSHIP (Switzerland)
Ship type	Fruit Juice Tanker
Treatment capacity	250 m ³ /h x 1set
Period	Feb – March, 2015

- On board survey
3D Laser Scanning
- Installation
- Commissioning
- Complete



Material consumption

ITEM	SPEC'	Q'TY (pcs)	WEIGHT (kg)
PIPE (MAIN LINE)	250A (10")	43	1,719
PIPE (DRAIN)	40A (1 1/2")	12	68
SEAT & SUPPORT	-	50	615
CABLE	-	2,220m	782

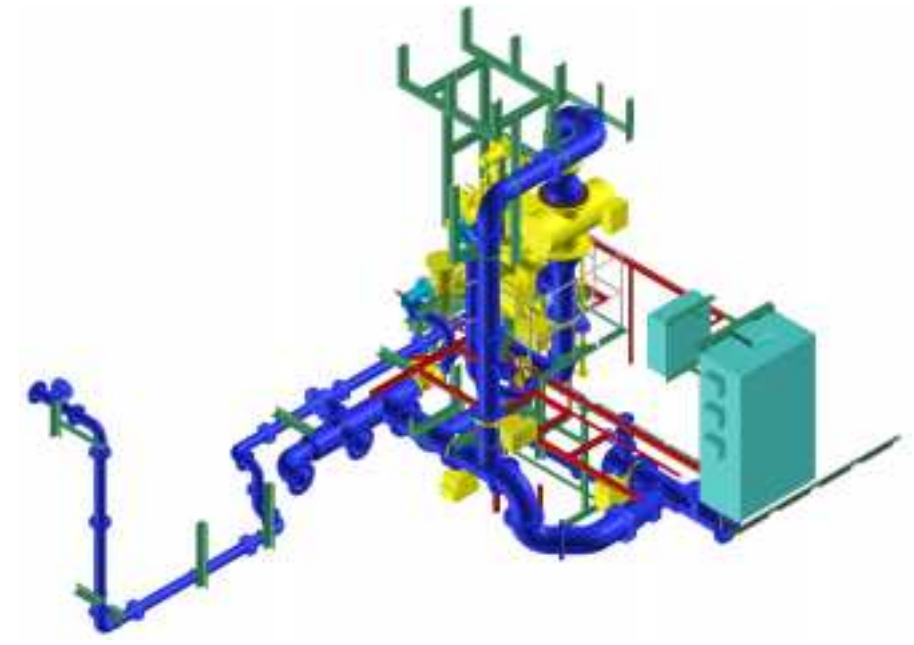

ORANGE WAVE Retrofit Project



Before



Before

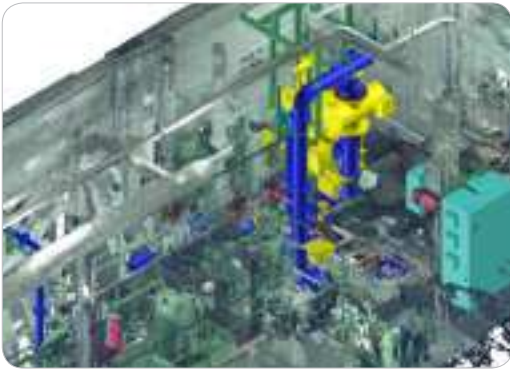

After



After



Before



After

PANASIA

BALLAST WATER MANAGEMENT SYSTEM
GloEn-Patrol™



Let's **GloEn-Patrol™** for the Ocean.

GloEn-Patrol™ symbolizes that PANASIA patrols around the globe to protect Ocean Environment against harmful aquatic species. Do GloEn-Patrol™ for your better life.

GloEn-Patrol™

Ballast Water Treatment System

- Filtration & UV Irradiation



With experiences specializing in shipbuilding industries and skilled people understanding the characteristics of shipping industries, PANASIA came up and provided the **easiest, safest, and simplest solution for ballast water treatment system** based on effective filtration and UV irradiation since 2010 when acquired its type approvals. This technology has been proved and widely used to disinfect the harmful organisms in the ballast water without producing any toxic substance.

This simple configuration of GloEn-Patrol™ is combined the filtration unit with 50µm filter element which provides the most effective and efficient back flushing function than any other conventional filters can do and medium pressured UV lamps which give customers assurance to last long life to treat and disinfect the ballast water in ballasting and de-ballasting stage. In addition, this uniquely engineered and designed filter and UV lamp are manufactured by PANASIA's own technologies to provide the upmost quality, reasonable price and on time delivery to the customers.

The system flow has four types. In order to acquire an appropriate dose of UV lamps, system uses warming up mode in which sea water passes filter & UV but not flow into ballast tank. When system sets up, ballasting mode starts. In the mode, the ballast water from sea chest enters through the inlet pipe into the filter and flows through the cylindrical filter element from inside out. Organisms larger than 50 µm are eliminated and those smaller than 50µm will pass into UV unit for disinfection. During filtration, sediments are accumulated on the surface of filter element and it is flushed out to overboard by the backflushing function without any disturbance on filter operation. During de-ballasting mode, the ballast water from the ballast tanks passes through the UV unit to prevent reproduction of organisms and flows out to overboard. During Bypass mode, the ballast water skips filter and UV unit and simply flows out to overboard.

FEATURES

- Superior treatment performance(100% physical treatment type)
- 3-steps automatic adjustment of power consumption according to water quality
- Low maintenance cost
- User friendly operating system
- Automatic back-flushing(Filter), Auto Cleaning(UV Lamp sleeve) function
- No limitation on salinity and water temperature for the treatment
- No use of any chemical, producing corrosion in ballast tanks
- Most suitable application for a variety of installation environment
(Vertical/Horizontal installation and no limitation on the distance of main components)

FLOW DIAGRAM (GloEn-P1500)

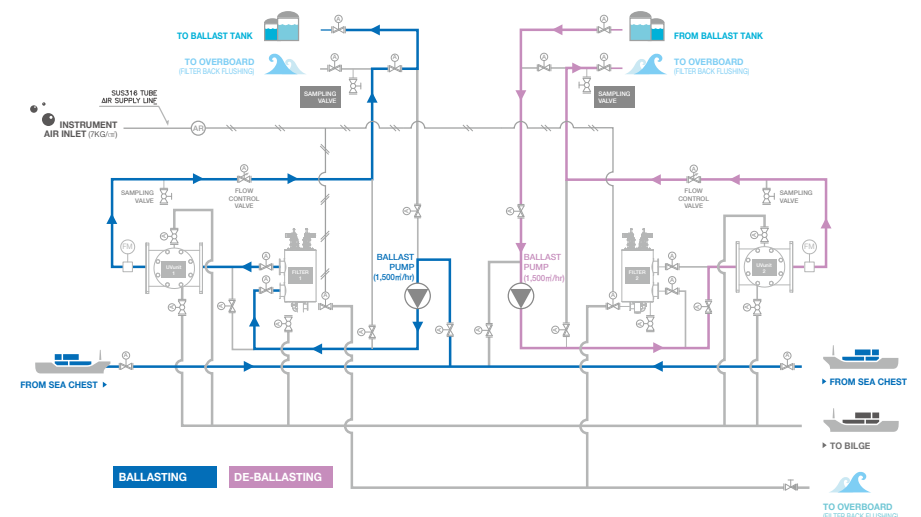

GloEn-Patrol™

Simple, Safe and Smart

PRODUCT LINE UP

	GloEn-Patrol™ G I	GloEn-Patrol™ G II	GloEn-Patrol™ G III
			
Component	Original Filter Unit Original UV Unit	MEGA Filter Unit Original UV Unit	MEGA Filter Unit MEGA UV Unit
Treatment Capacity	50 ~ 750m³/hr	800 ~ 3,000m³/hr	800 ~ 3,000m³/hr
Feature	Small capacity in single unit	Less footprint & Power consumption in large capacity	Large capacity in single unit with high efficiency

CERTIFICATES

							
IECEX Type Approved Jan. 2015	DNV Type Approved Sep. 2014	CCS Type Approved Mar. 2014	JG Type Approved Mar. 2014	BV Type Approved May 2013	USCG AMS Approved Apr. 2013	ABS Type Approved Mar. 2013	
							
LR Type Approved Aug. 2012	RINA Type Approved Aug. 2012	CR Type Approved Sep. 2011	RMRS Type Approved Sep. 2011	Netherlands Flag Approved Aug. 2010	EX-PROOF Type DNV ATEX Approved Jun. 2010	G8 IMO Approved Mar. 2010	G9 IMO Approved Mar. 2010

INSTALLATION COMPARISON BETWEEN G I AND G III MODEL



Treatment capacity
3,000 m³/hr

**Improved
In space & Power Consumption**



Treatment capacity 3,000 m³/hr

High Efficiency _ **40%** of power consumption is reduced.

Model	Treatment Capacity	Power Consumption		Reduced by
		GloEn-Patrol™ G I	GloEn-Patrol™ G III Min. Max.	
P1000	1,000 m³/hr	120kW	56kW 77kW	36%
P1200	1,200 m³/hr	160kW	65kW 90kW	44%
P1500	1,500 m³/hr	174kW	80kW 110kW	37%
P2000	2,000 m³/hr	240kW	113kW 155kW	35%
P2500	2,500 m³/hr	320kW	131kW 180kW	44%
P3000	3,000 m³/hr	360kW	164kW 225kW	38%



Minimized Footprint _ **44.5%** of installation area is reduced.

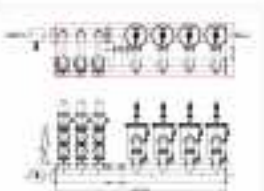

GloEn-Patrol™ G I
2.39m X 7.4m = **17.7m²**

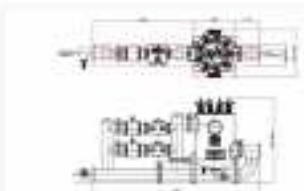

GloEn-Patrol™ G III
2.19m X 1.9m + 0.97(1.17+4.67) = **9.83m²**



Simple Configuration Filter Unit

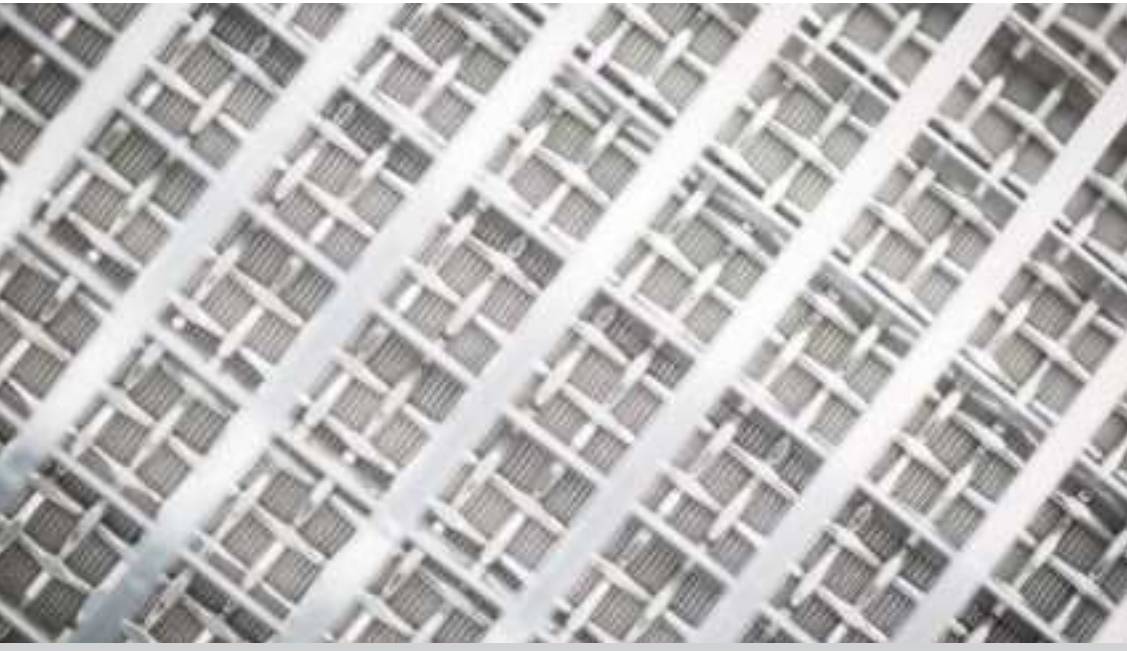

SCREEN TYPE FILTER

The ballast water enters into the filter and flows through the cylindrical filter element from inside out. The filtration cake accumulating on the filter element surface causes pressure difference to develop across the filter element. The back-flushing begins when the pre-set pressure difference between inlet and outlet on the filter is reached or pre-determined lapse of time is met. During the backflushing cycle, the filtering is not interrupted and continues to flow downstream of the filter in the normal manner. Regardless of

this outstanding technology, Original Filter has met challenges when pump capacity gets bigger, the number of filter units increase simultaneously, requiring more footprint reluctantly. As a solution to this concern, we've developed MEGA Filter Unit to appropriately apply for bigger capacity (from 900m³/hr up to 3,000m³/hr), providing multi-cylindrical filter elements to maximize the performance for the filter unit with less footprint (approx. 44.5%) compared to Original Filter.

COMPONENT LINE-UP

	Model	Treatment Capacity
Original Filter Unit	PF 250	250 m ³ /hr
	PF 500	500 m ³ /hr
	PF 750	750 m ³ /hr
MEGA Filter Unit	PF 900	900 m ³ /hr
	PF 1200	1,200 m ³ /hr
	PF 1500	1,500 m ³ /hr
	PF 2000	2,000 m ³ /hr
	PF 2500	2,500 m ³ /hr
	PF 3000	3,000 m ³ /hr

	Original Filter Unit		MEGA Filter Unit
Type	Single screen type	Type	Multi cage screen type
Capacity	250 ~ 750 m ³ /hr	Capacity	900 ~ 3,000 m ³ /hr
Operating Pressure	5 bar (option 10 bar)	Operating Pressure	5 bar (option 10 bar)
Grade of filtration	50µm	Grade of filtration	50µm
Filter Element Material	SUS 316L / Hastelloy	Filter Element Material	SUS 316L / Hastelloy
Backflushing control	Differential Pressure -dependent	Backflushing control	Differential Pressure -dependent

Simple Configuration UV Unit

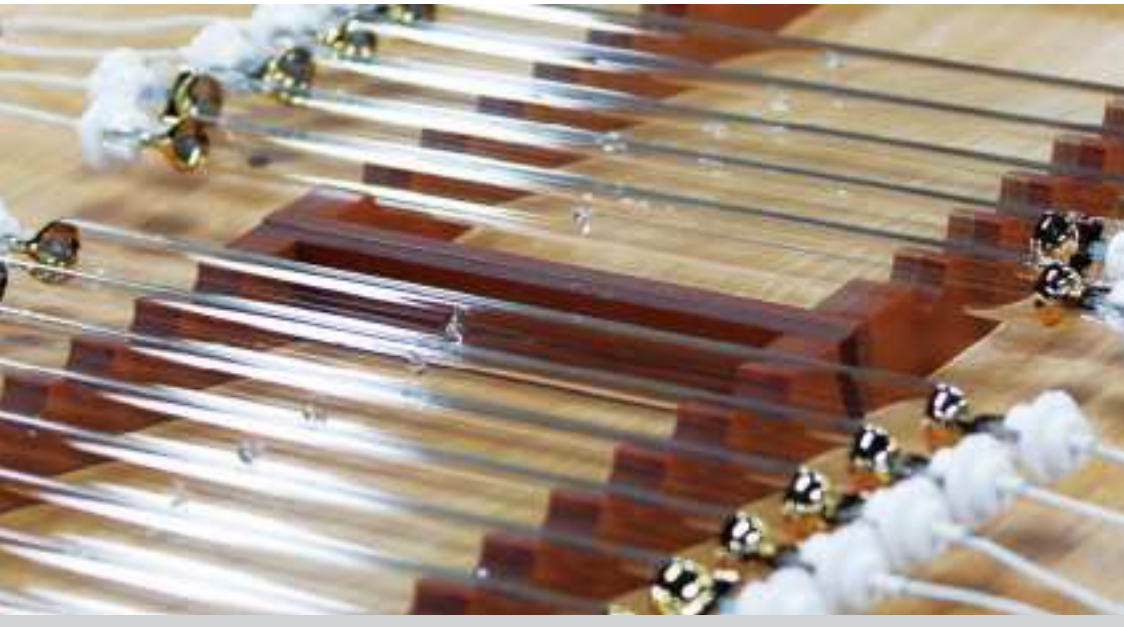

For the BWTS based on the filtration and UV technology, the other important part for an assurance of its operation is to guarantee the performance of UV lamps. GloEn-Patrol™ uses the UV lamps which are especially engineered, designed and manufactured by PANASIA in ballast water disinfection purpose. The intensity of UV lamp is automatically adjusted by three levels according to flow rate, and transmittance to assure stable UV lamp performance. GloEn-Patrol™ uses medium pressure UV lamps that output a variety of wavelength and enables to treat more various micro-organisms compared to any other UV lamps. To maintain the cleaned quartz sleeve

condition, automatic wiping function is adopted that cleans the quartz sleeve by wiper's back and forth movement. Although this excellent performance is guaranteed, there's no harmful and toxic chemicals neither required nor produced for running our system. Basically it is 100% safe treatment method.

With the attitude of listening customer's thoughtful comments, we have developed, a brand new MEGA UV Unit, treating even bigger capacity with less footprint by reducing the power consumption of approx. 40% compared with Original UV unit so that GloEn-Patrol™ can be confidently supplied for bigger vessels.

COMPONENT LINE-UP

	Model	Treatment Capacity
Original UV Unit	PU 250	150 m ³ /hr
		250 m ³ /hr
		350 m ³ /hr
MEGA UV Unit	PU 500	500 m ³ /hr
		700 m ³ /hr
	PU 1000	1,000 m ³ /hr
	PU 1250	1,250 m ³ /hr
	PU 1500	1,500 m ³ /hr

Original UV Unit	MEGA UV Unit
------------------	--------------



Capacity	150 ~ 700 m ³ /hr	Capacity	1,000 ~ 1,500 m ³ /hr
Operating Pressure	7 bar	Operating Pressure	7 bar
Automatic cleaning wiper		Automatic cleaning wiper	
Explosion Proof Type (option)		Explosion Proof Type (option)	

Simple Configuration Panels

CONTROL PANEL



The monitor & control panel is PLC based and configured to activate and deactivate UV lamps via UV power supply panels in order to maintain the sufficient UV dose while conserving power.

The monitor & control panel offers a real time monitoring of the status of system operation while logging the data required by the convention at the same time.

- Smart HMI system
- Data logging for 24 months
- Main data real time display
(Position, Pressure, Flow, Temperature, etc)
- Alarm function (Interface with AMS or Load master)
- Controller: Siemens PLC
- Touch screen
- Operation Temperature: 0 ~ 55 °C

UV POWER SUPPLY PANEL



The major function of Power Supply Panel is to operate the medium pressure UV lamps UV. It controls the strength of UV lamps with the capacitors mounted in the Panel. Also it detects whether the UV lamps are functioning properly or not. The temperature sensor is mounted inside to monitor temperature in order to give an alarm to an operator and shut down the system in case of overheating.

- Operation Temperature: 0 ~ 55 °C
- Prevent high heat dissipation

Worldwide Service Network

Effective Follow-up Service, Prompt Action for Spare Parts.

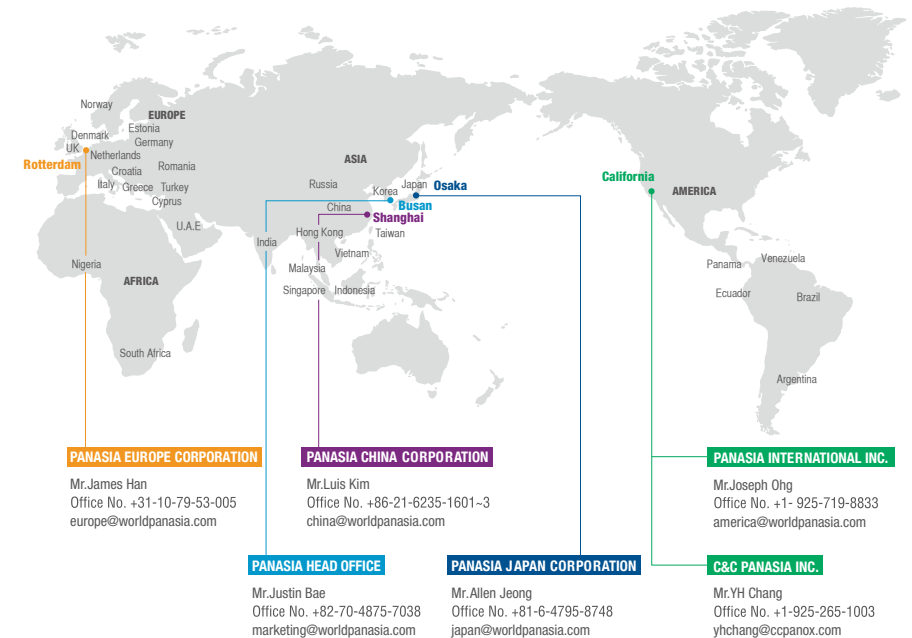



HEAD OFFICE & FACTORY	46744, 55, Mieumsandan 3-ro, Gangseo-gu, Busan, Korea TEL: +82-51-831-1010 FAX: +82-51-831-1399 www.worldpanasia.com E-mail: panasia@worldpanasia.com
MARKETING	TEL: +82-70-4875-7039 E-mail: marketing@worldpanasia.com
SERVICE	BWTS TEL: +82-70-4875-7147 E-mail: bwts_service@worldpanasia.com TLGS TEL: +82-70-4875-7145 E-mail: tlgs_service@worldpanasia.com